



中山市晶博光电科技有限公司

ZHONGSHAN KINGHOOD OPTOELECTRONICS CO.,LTD.

DATA SHEET

PART NO. : S03GN5C1

DATE : 2009-11-12

DEPARTMENT : R&D

REVISION : 1

RECEIVED			
<input type="checkbox"/> MASS PRODUCTION			
<input checked="" type="checkbox"/> PRELIMINARY			
<input type="checkbox"/> CUSTOMER DESIGN			
DEVICE NUMBER :		JBDL-S03-042	
PAGE :		4	
CUSTOMER	DESIGNER	CHECKER	APPROVER

REV.	DESCRIPTION	RELEASE DATE

Address: Bld.8,Fuwan Industrial Zone,Eastern,Zhongshan,Guangdong,China

TEL : (+86 760) 86185231 86185232 86185233 86185201

FAX : (+86 760) 86185230

E-mail:Sales@kinghood.cc

Http://www.kinghood.cc



中山市晶博光电科技有限公司

ZHONGSHAN KINGHOOD OPTOELECTRONICS CO.,LTD.

Device Number: JBDL-S03-042

REV: 1.0

7.62*2.5mm Cannibal Type LED Lamps

Model No.: S03GN5C1

ECN: _____

Page: 1/4

■ Features :

- High radiant intensity
- Choice of various viewing angles
- Reliable and robust

■ Descriptions :

- The series is specially designed for applications requiring higher brightness.
- The led lamps are available with different colors, intensities, epoxy colors, etc.

■ Applications :

- TV set
- Monitor
- Telephone
- Computer

■ Package Dimensions:

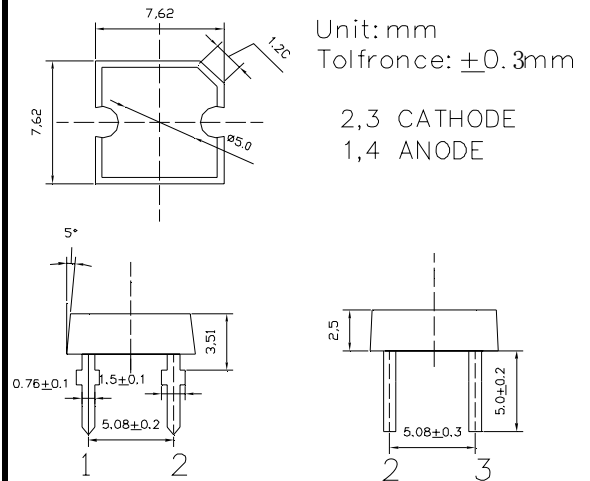

- Notes:**
1. All dimensions are in millimetres
 2. An epoxy meniscus may extend about 1.5mm(0.059") down to the lead.
 3. Tolerances unless Dimension ± 0.25 mm.

PART NO.	Chip		Lens Color
	Material	Emitted Color	
S03GN5C1	GaP	Green	Water Clear

Address: Bld.8,Fuwan Industrial Zone,Eastern,Zhongshan,Guangdong,China

TEL : (+86 760) 86185231 86185232 86185233 86185201

FAX : (+86 760) 86185230

E-mail: Sales@kinghood.cc

Http://www.kinghood.cc

Prepared by: George

Prepared date: 09-11-12

910044



中山市晶博光电科技有限公司

ZHONGSHAN KINGHOOD OPTOELECTRONICS CO.,LTD.

Device Number: JBDL-S03-042

REV: 1.0

7.62*2.5mm Cannibal Type LED Lamps

Model No.: **S03GN5C1**

ECN: _____ Page: 2/4

Absolute Maximum Ratings at Ta = 25°C

Parameter	Symbol	Rating	Unit
Forward Current	IF	60	mA
Operating Temperature	Topr	-40 to +85	°C
Storage Temperature	Tstg	-40 to +100	°C
Electrostatic Discharge	ESD	2000	V
Soldering Temperature	Tsol	260 ± 5	°C
Power Dissipation	Pd	120	mW
Peak Forward Current	IF(Peak)	100	mA
Reverse Voltage	VR	7	V

Note: *1:IFP Conditions --Pulse Width ≤ 1msec and Duty ≤ 1/10.

*2:Soldering time ≤ 5 seconds.

Electro-Optical Characteristics (Ta=25°C)

Parameter	Symbol	Condition	Min.	Typ.	Max.	Unit
Forward Voltage	VF	IF= 40 mA	/	3.0	3.4	V
Reverse Current	IR	VR= 7 V	/	/	2	μA
Luminous Intensity	Iv	IF= 40 mA	800	3000	6000	mcd
Viewing Angle	2θ 1/2	IF= 40 mA	/	120	/	deg
Peak Wavelength	λp	IF= 40 mA	/	520	/	nm
Dominant Wavelength	λd	IF= 40 mA	/	523	/	nm
Spectrum Radiation Bandwidth	△λ	IF= 40 mA	/	35	/	nm

Address: Bld.8,Fuwan Industrial Zone,Eastern,Zhongshan,Guangdong,China

TEL : (+86 760) 86185231 86185232 86185233 86185201

FAX : (+86 760) 86185230

E-mail:Sales@kinghood.cc

Http://www.kinghood.cc

Prepared by : George

Prepared date : 09-11-12

910044



7.62*2.5mm Cannibal Type LED Lamps

Model No.: S03GN5C1

ECN: _____

Page: 3/4

■ Typical Electro-Optical Characteristic Curves:

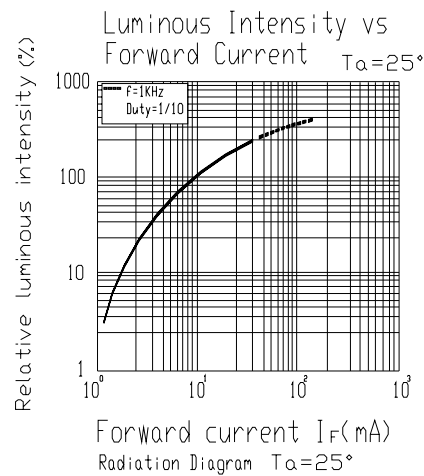
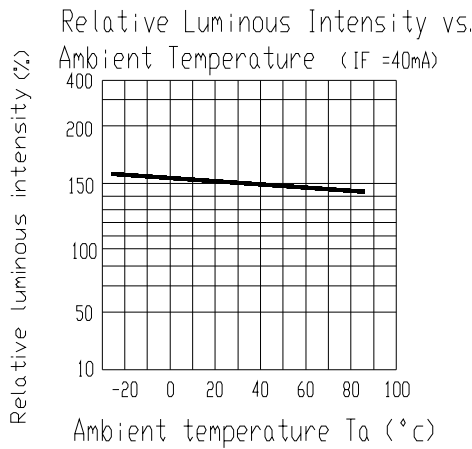
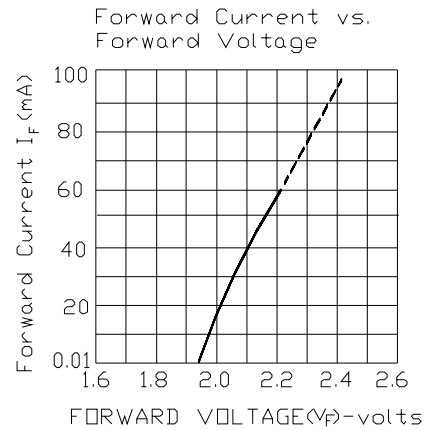
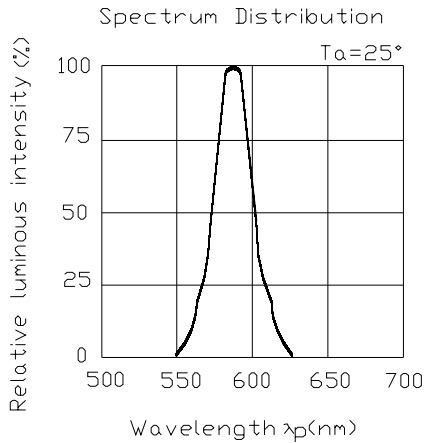

Forward Current Derating Curve

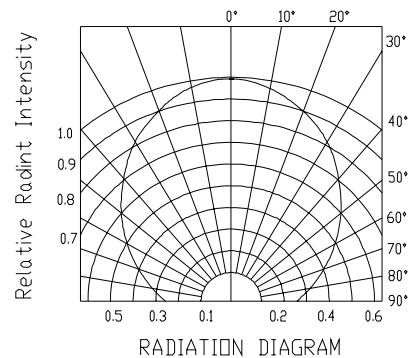
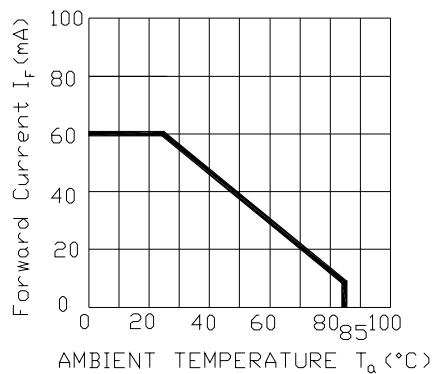

Address: Bld.8,Fuwan Industrial Zone,Eastern,Zhongshan,Guangdong,China

TEL : (+86 760) 86185231 86185232 86185233 86185201

Prepared date : 09-11-12

FAX : (+86 760) 86185230

Prepared by : George

E-mail:Sales@kinghood.cc

Http://www.kinghood.cc

910044



中山市晶博光电科技有限公司
ZHONGSHAN KINGHOOD OPTOELECTRONICS CO.,LTD.

Device Number: JBDL-S03-042

REV: 1.0

7.62*2.5mm Cannibal Type LED Lamps

Model No.: S03GN5C1

ECN: _____

Page: 4/4

■ Reliability test items and conditions:

NO	Item	Test Conditions	Test Hours/Cycle	Sample size	Ac/Re
1	Solder Heat	TEMP : 260°C ± 5 °C	10 SEC	76 PCS	0/1
2	Temperature Cycle	H : +100°C 15min ∩ 5 min L : -40°C 15min	300 CYCLES	76 PCS	0/1
3	Thermal Shock	H : +100°C 5min ∩ 10 sec L : -10°C 5min	300 CYCLES	76 PCS	0/1
4	High Temperature Storage	TEMP : 100°C	1000 HRS	76 PCS	0/1
5	Low Temperature Storage	TEMP : -40°C	1000 HRS	76 PCS	0/1
6	DC Operating Life	TEMP : 25°C IF = 40mA	1000 HRS	76 PCS	0/1
7	High Temperature/ High Humidity	85°C / 85% RH	1000 HRS	76 PCS	0/1

*Iv: BRIGHTNESS ATTENUATE DIFFERENCE(1000hrs) < 10%

*VF: FORWARD VOLTAGE DIFFERENCE < 3%

Address: Bld.8,Fuwan Industrial Zone,Eastern,Zhongshan,Guangdong,China

TEL : (+86 760) 86185231 86185232 86185233 86185201

FAX : (+86 760) 86185230

E-mail:Sales@kinghood.cc

Http://www.kinghood.cc

Prepared date : 09-11-12

Prepared by : George

910044