



# 中山市晶博光电科技有限公司

## ZHONGSHAN KINGHOOD OPTOELECTRONICS CO.,LTD.

Device Number: JBDL-5R7-017

REV: 1.0

### 4.8mm Round Type LED Lamps

Model No.: **5R7A2DBXXC**

ECN: \_\_\_\_\_

Page: 1/4

#### ■ Features :

- High radiant intensity
- Choice of various viewing angles
- Reliable and robust

#### ■ Descriptions :

- The series is specially designed for applications requiring higher brightness.
- The led lamps are available with different colors, intensities, epoxy colors, etc.

#### ■ Applications :

- TV set
- Monitor
- Telephone
- Computer

#### ■ Package Dimensions:

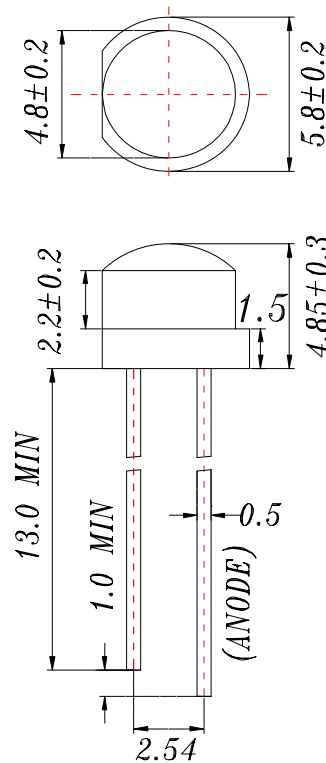

- Notes:**
1. All dimensions are in millimetres
  2. An epoxy meniscus may extend about 1.5mm(0.059") down to the lead.
  3. Tolerances unless Dimension  $\pm 0.25$ mm.

PART NO.	Chip		Lens Color
	Material	Emitted Color	
5R7A2DBXXC	InGaN/SiC	Blue	Water Clear

Address: Bld.8,Fuwan Industrial Zone,Eastern,Zhongshan,Guangdong,China

TEL : (+86 760) 86185231 86185232 86185233 86185201

FAX : (+86 760) 86185230

E-mail:Sales@kinghood.cc

Http://www.kinghood.cc

Prepared by: George

Prepared date: 09-7-10

907028



# 中山市晶博光电科技有限公司

ZHONGSHAN KINGHOOD OPTOELECTRONICS CO.,LTD.

Device Number: JBDL-5R7-017

REV: 1.0

4.8mm Round Type LED Lamps

Model No.: 5R7A2DBXXC

ECN: \_\_\_\_\_

Page: 2/4

## ■ Absolute Maximum Ratings at Ta = 25°C

Parameter	Symbol	Rating	Unit
Forward Current	IF	30	mA
Operating Temperature	Topr	-40 to +85	°C
Storage Temperature	Tstg	-40 to +100	°C
Electrostatic Discharge	ESD	2000	V
Soldering Temperature	Tsol	260 ± 5	°C
Power Dissipation	Pd	120	mW
Peak Forward Current	IF(Peak)	100	mA
Reverse Voltage	VR	7	V

Note: \*1:IFP Conditions --Pulse Width ≤ 1msec and Duty ≤ 1/10.

\*2:Soldering time ≤ 5 seconds.

## Electro-Optical Characteristics (Ta=25°C)

Parameter	Symbol	Condition	Min.	Typ.	Max.	Unit
Forward Voltage	V <sub>F</sub>	I <sub>F</sub> = 20 mA	3.0	3.2	3.4	V
Reverse Current	I <sub>R</sub>	V <sub>R</sub> = 7 V	/	/	2	μA
Luminous Intensity	I <sub>v</sub>	I <sub>F</sub> = 20 mA	90	/	300	mcd
Viewing Angle	2θ 1/2	I <sub>F</sub> = 20 mA	/	160	/	deg
Peak Wavelength	λ <sub>p</sub>	I <sub>F</sub> = 20 mA	462	465	468	nm
Dominant Wavelength	λ <sub>d</sub>	I <sub>F</sub> = 20 mA	464	467	470	nm
Spectrum Radiation Bandwidth	Δλ	I <sub>F</sub> = 20 mA	/	26	/	nm

BIN#	M5	M6	M7	M8
I <sub>v</sub> (mcd) @I <sub>F</sub> =20mA	77-108	108-151	151-211	211-295
BIN#	M9			
I <sub>v</sub> (mcd) @I <sub>F</sub> =20mA	295-413			

Address: Bld.8,Fuwan Industrial Zone,Eastern,Zhongshan,Guangdong,China

TEL : (+86 760) 86185231 86185232 86185233 86185201

FAX : (+86 760) 86185230

E-mail:Sales@kinghood.cc

Http://www.kinghood.cc

Prepared by : George

Prepared date : 09-7-10

907028



4.8mm Round Type LED Lamps

Model No.: **5R7A2DBXXC**

ECN: \_\_\_\_\_

Page: 3/4

■ Typical Electro-Optical Characteristic Curves:

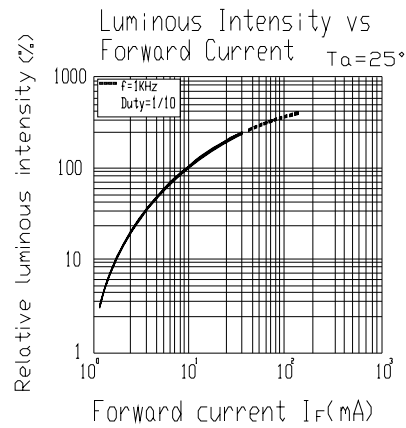
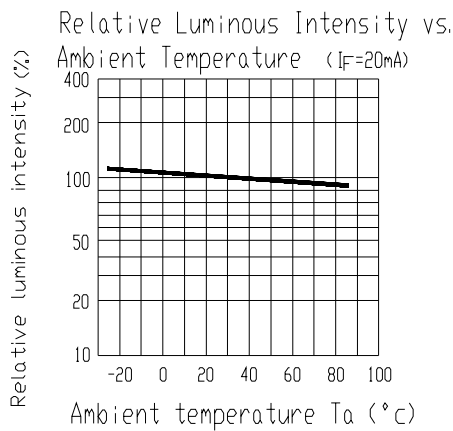
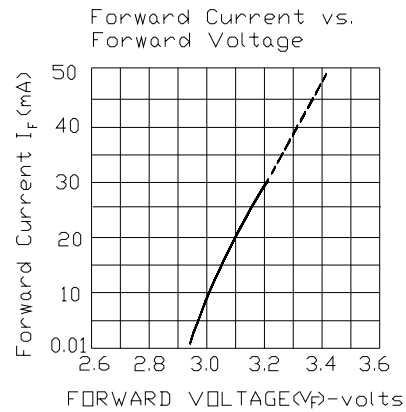
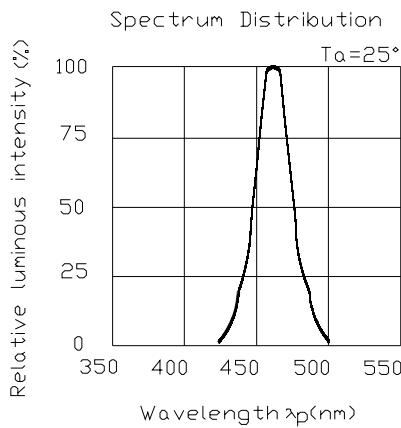

Forward Current Derating Curve

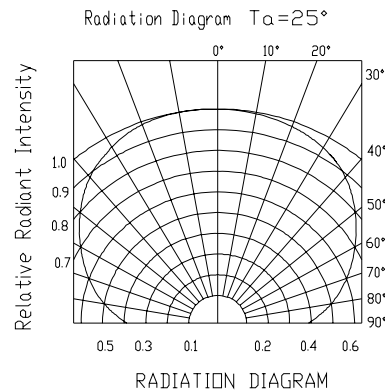
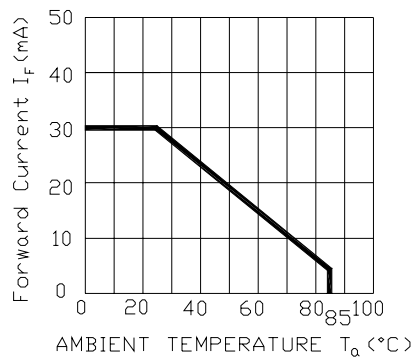

Address: Bld.8,Fuwan Industrial Zone,Eastern,Zhongshan,Guangdong,China

TEL : (+86 760) 86185231 86185232 86185233 86185201

Prepared date : 09-7-10

FAX : (+86 760) 86185230

Prepared by : George

E-mail:Sales@kinghood.cc

Http://www.kinghood.cc

907028



# 中山市晶博光电科技有限公司

## ZHONGSHAN KINGHOOD OPTOELECTRONICS CO.,LTD.

Device Number: JBDL-5R7-017

REV: 1.0

4.8mm Round Type LED Lamps

Model No.: 5R7A2DBXXC

ECN: \_\_\_\_\_

Page: 4/4

■ Reliability test items and conditions:

NO	Item	Test Conditions	Test Hours/Cycle	Sample size	Ac/Re
1	Solder Heat	TEMP : 260°C ± 5 °C	10 SEC	76 PCS	0/1
2	Temperature Cycle	H : +100°C 15min ∩ 5 min L : -40°C 15min	300 CYCLES	76 PCS	0/1
3	Thermal Shock	H : +100°C 5min ∩ 10 sec L : -10°C 5min	300 CYCLES	76 PCS	0/1
4	High Temperature Storage	TEMP : 100°C	1000 HRS	76 PCS	0/1
5	Low Temperature Storage	TEMP : -40°C	1000 HRS	76 PCS	0/1
6	DC Operating Life	TEMP : 25°C IF = 20mA	1000 HRS	76 PCS	0/1
7	High Temperature/ High Humidity	85°C / 85% RH	1000 HRS	76 PCS	0/1

\*Iv: BRIGHTNESS ATTENUATE DIFFERENCE(1000hrs) < 10%

\*VF: FORWARD VOLTAGE DIFFERENCE < 3%

Address: Bld.8,Fuwan Industrial Zone,Eastern,Zhongshan,Guangdong,China

TEL : (+86 760) 86185231 86185232 86185233 86185201

FAX : (+86 760) 86185230

E-mail:Sales@kinghood.cc

Http://www.kinghood.cc

Prepared date : 09-7-10

Prepared by : George

907028